

2012+ Jeep / 18+ Durango SRT8 H.O. Intercooled System **Installation Guide**





The **ULTIMATE** Power Adder™

Accessible Technologies, Inc.
 14801 W. 114th Terrace
 Lenexa, KS 66215
 Phone: 913.338.2886
 Fax: 913.338.2879
 techserv@procharger.com

All rights reserved. Accessible Technologies Inc. hereby grants permission to use and reproduce this document for personal use, provided that all copyright information be retained. Reproduction of this document for unauthorized commercial use is strictly prohibited.

Information in this document is subject to change without notice.

ProCharger is a registered trademark and The Intercooled Supercharging Experts![™] and Designed to Blow Away the Competition[™] are trademarks of Accessible Technologies, Inc. and may not be used without express permission.

TORQUE SPECIFICATION CHART	 GRADE 5			 GRADE 8		
	Thread Size	Torque (lb.ft.)			Torque (lb.ft.)	
1/4-20	11	8	7	16	12	10
1/4-28	13	10	8	18	14	11
5/16-18	23	17	14	33	25	20
5/16-24	26	19	15	36	27	22
3/8-16	41	31	25	58	44	35
3/8-24	47	35	28	66	49	39
7/16-14	66	49	40	93	70	56
1/2-13	101	75	60	142	106	85
1/2-20	113	85	68	160	120	96

INTRODUCTION

Congratulations on purchasing your ProCharger® 2012+ Jeep / 2018+ Durango SRT8

Intercooled System. Read this entire manual before you attempt to install your ProCharger kit. It is imperative that you follow all of the instructions in the order they appear in this installation guide. If you have any questions regarding any aspect of this installation, call us at (913) 338-2886.

For best results, we recommend reviewing the installation instructions beforehand, and following the installation instructions closely and in sequence. A detailed packing list has been provided to assist you in identifying the components of your ProCharger system.

You should also have the following gauges available to properly check the finished installation and monitor your vehicle's performance (especially for testing):

- Manifold Boost Pressure Gauge
- Fuel Pressure Gauge
- Wide Band Oxygen Sensor and Gauge

Gauges should be of a type that can be read from the cockpit while performing a wide-open throttle road test. Cockpit or hood-mounted gauges are preferable. In order to obtain usable readings, the gauges should measure pressure at the intake manifold and fuel rail. IF VEHICLE DOES NOT MAINTAIN PROPER FUEL PRESSURE (50-65 PSI), DECREASE THROTTLE APPLICATION IMMEDIATELY. In some cases, extra vehicle modifications can strain the stock fuel pump. If your vehicle has difficulty retaining adequate fuel pressure, contact ATI ProCharger about the availability of an upgraded fuel system.

The engine on which the ProCharger® is to be installed should retain the factory compression ratio. If it has been modified in any way, please consult ProCharger staff before proceeding with the installation. This supercharger system is intended for use on STOCK, strong, well-maintained engines/transmissions. Installation on a worn or troublesome powertrain should be reconsidered. ATI PROCHARGER WILL NOT BE HELD RESPONSIBLE FOR DAMAGE TO A VEHICLE'S POWERTRAIN. ATI ProCharger is not responsible for ECM tuning/programming on non-stock vehicles. ATI PROCHARGER recommends verifying that your vehicle has current ECM updates from the vehicle manufacturer before installation.

For best performance and reliability, always use premium grade fuel (91 octane or higher) and listen closely for signs of detonation, which might sound like ball bearings rolling around in a tin can. IF DETONATION SHOULD OCCUR, OR IF YOU ARE UNSURE WHETHER WHAT YOU'RE HEARING IS DETONATION, DECREASE THROTTLE APPLICATION IMMEDIATELY and please consult ATI ProCharger staff. Detonation should not be an issue with a properly installed intercooled supercharger system, though OEM factory-shipped engine and parts inconsistencies are possible on any vehicle.

Required Tools and Supplies

- 3/8" & 1/2" Socket Sets (standard & metric)
- Open End Wrench Set (standard & metric)
- 3/8" Hex Bit Set (allen head)
- Flat Screwdrivers
- 5/16 Nut Driver
- Torque Wrench
- Phillips Screwdrivers
- Plier Set
- Right Angle Drill
- Coolant
- Power Steering Fluid
- Pipe Thread Sealant



Warning: Your supercharged Jeep must always be run on 91 octane or higher gas. Do not run vehicle at wide-open throttle if you have less than 1/4 tank

TABLE OF CONTENTS

Introduction i

Stock Component Removal..... 1

Crank Pulley..... 13

Supercharger Bracket Assembly 15

Procharger Head Unit 18

Tensioner 19

Intercooler 20

Washer Tank..... 29

Coolant Reservoir 31

Vacuum Manifold 32

Surge System 33

Fuel System 34

Finishing..... 36

Operation and Maintenance 39

Limited Warranty 41

TUNING IS REQUIRED WHEN INSTALLING YOUR PROCHARGER SYSTEM. IF A COMPLETE SYSTEM WAS PURCHASED. SEE SUPPLEMENTAL TUNING GUIDE. IF A TUNER KIT WAS PURCHASED. TUNING WILL HAVE TO BE PERFORMED BEFORE OPERATING THE VEHICLE.



Tech Tip: *Installing spark plugs that are one heat range colder than stock and gapping your plugs to .035" is recommended.*

STOCK COMPONENT REMOVAL

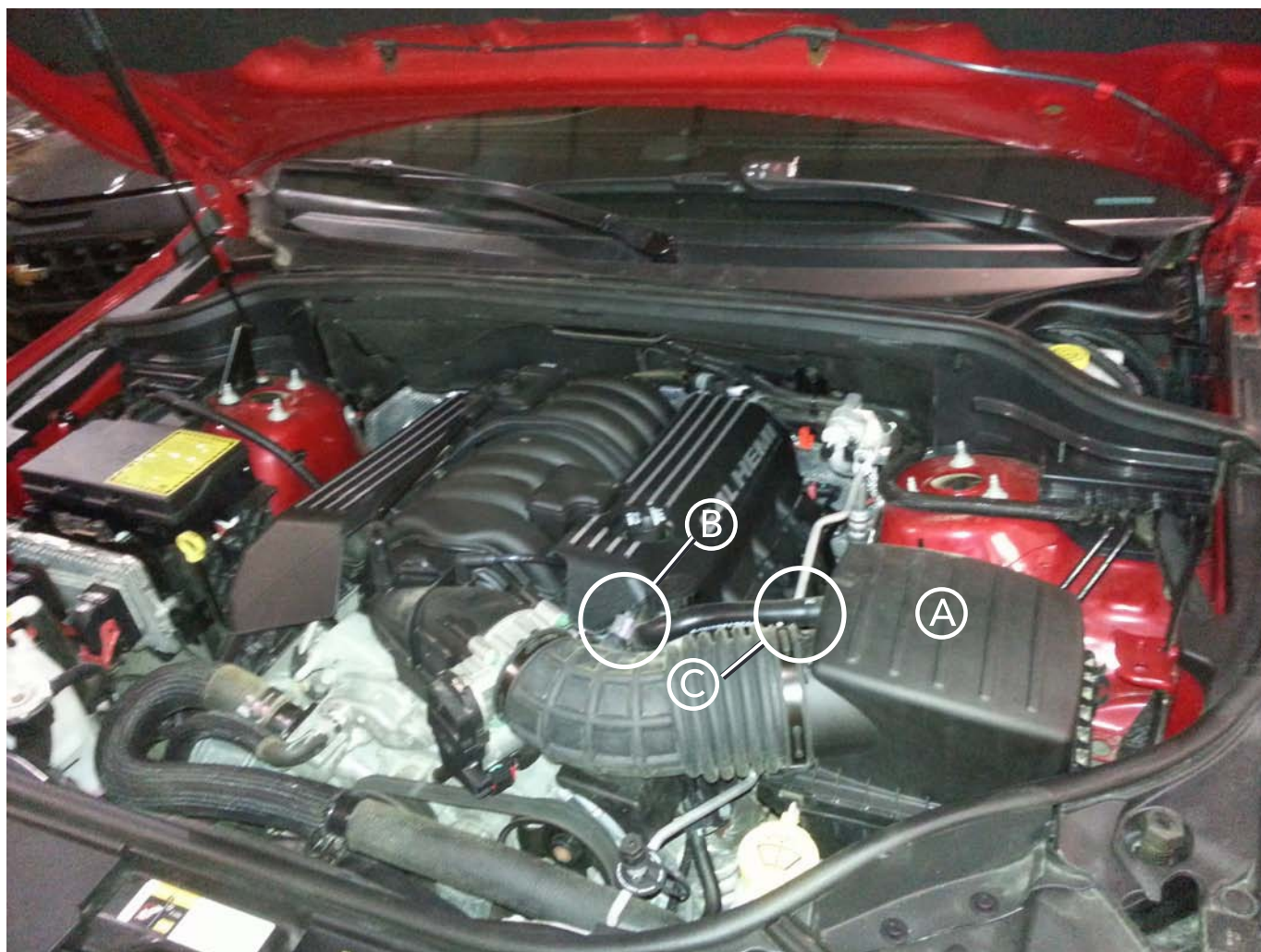

Completion of this section will configure the vehicle for system installation:

- (A) Factory Air Filter Box
- (B) Intake Air Temp. Sensor
- (C) PCV Tube

! **Warning:** Read and understand all safety precautions in this manual before installation. Failure to comply with instructions in this manual could result in personal injury, property damage, and/or voiding your warranty.

Engine Air Filter

- 1 Disconnect the battery ground located under the passenger seat.
- 2 Remove the IAT (Intake Air Temperature) sensor.
- 3 Remove the PCV Hose from the intake assembly.
- 4 Loosen the band clamp from the air filter assembly to throttle body connection with an 8mm nut driver.
- 5 Remove the air box by pulling up on the assembly.
- 6 Unclip the wiring harness from the plastic tray that sits under the air box assembly. Remove the plastic tray.



IAT Sensor & PCV Connection



Wiring Harness Clip



Airbox Assembly Removed

Front Fascia Jeep

Durango proceed to page: 10

- 1 2014+:
Using a flat head screwdriver remove the (2) clips holding the core support cover to the radiator core support
2012-2013 Skip to step 2.



Core Support Cover Clips

- 2 Using a jack raise the front of the vehicle and support with jack stands.



Wheel Liner Clips

- 3 Cut the heads off of the (4) plastic push clips holding the wheel liner to the fascia. Repeat on the other side. New push pins will be reinstalled.

- 4 Using a 10mm socket remove the bolt holding the wheel liner to the fascia. Repeat for the other side.



Wheel Liner Bolt

Stock Component Removal

2012-16 Models Only.
2017+ Proceed to step 7.

- Using a 10mm remove the (4) screws on the underside of the fascia connecting to the splash panel. Use a flathead screwdriver to remove the (5) push clips.



Fascia Screws & Clips (7 Of 9 Shown)

- Using a 13mm remove the (2) bolts and with a flat blade screw driver remove (1) clip holding the metal plate at the back of the splash panel.

Proceed to step 10.



Splash Panel Bolts & Clip

2017 Only.

- Using a 10mm remove the (11) screws on the underside of the fascia connecting to the splash panel. Cut the heads off the plastic rivets (aluminum rivets on some models) on each corner.



Fascia Screws (5 of 11 Shown)

- Using a 13mm remove the (4) bolts retaining the metal plate on the back of the splash panel. Remove the panel.



Metal Splash Panel Plate

- With a flat blade screwdriver remove the plastic clip retaining the back of the splash panel.



Rear Splash Panel Clip

- With an 8mm remove the (3) bolts holding the splash panel to the wheel liner. Repeat for the other side. Remove the splash panel. 2017+ models will have (2) plastic rivets per side that will need the heads cut off.



Splash Panel To Wheel Well Bolts (Drivers)

Stock Component Removal

- 11 Pull fender flare out far enough to be able to unclip fascia from the fender (each side).



Fender To Fascia Screw (2012-16 Models)

- 12 On drivers side unplug the connectors for the fog lights and the turn signals.



Fog Light & Turn Signal Connectors (Drivers)

- 13 On the passenger side unplug the fog light, turn signal and main fascia harness connector. Main fascia connector is on 2014+ models only.

2017+ Models continue to step 17.

- 14 Remove the fascia from the vehicle.

2012-13 Models continue to step 15.

2014-16 Models skip to page 13.



Fog, Turn Signal, Main Connectors (Pass)

2012-2013 models only.

- 15 With a 13mm remove the (2) bolts holding the grill to the radiator support.

- 16 Pull up on the plastic covers on the top of the grill to release the clips there are (4) total. Remove the grill.



2012-2013 Grill Bolts

2017+ Models only.

- 17 Pull the fascia out from the headlights and carefully remove the cover from the headlight squirter by pulling out on the clips and removing the cover. Repeat for the other side.

Continue to pg: 13

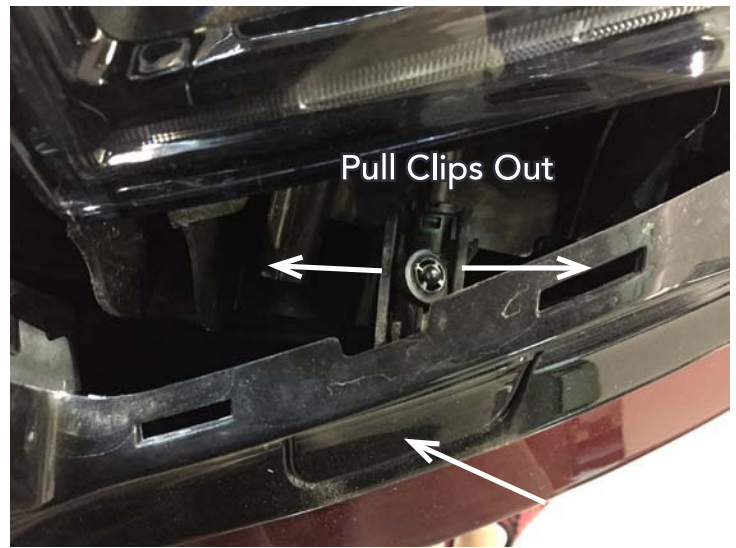

Headlight Squirter Cover

Front Fascia Durango

1 Using a flat head screwdriver remove the (2) clips holding the core support cover to the radiator support.



Core Support Cover Clips

2 Using a jack raise the front of the vehicle and support with jack stands.

3 Cut the heads off of the (2) plastic push clips holding the wheel liner to the fascia. Repeat for the other side.



Wheel Liner Clips

4 Pull the wheel trim panel away from the fascia/ fender to unclip it.

5 Using a 10mm remove the top bolt shown to the right, use an 8mm to remove the bottom bolt and a T-20 torx to remove the side screw.



Remove Hardware

- Using an 8mm remove (4) screws on the bottom of the inner fender.

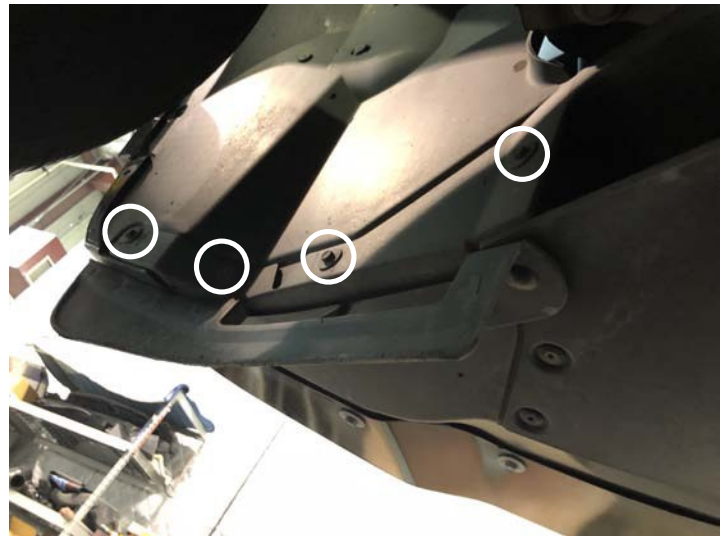

Inner Fender Screws

- With a 10mm remove (13) bolts securing the fascia to the splash panel.

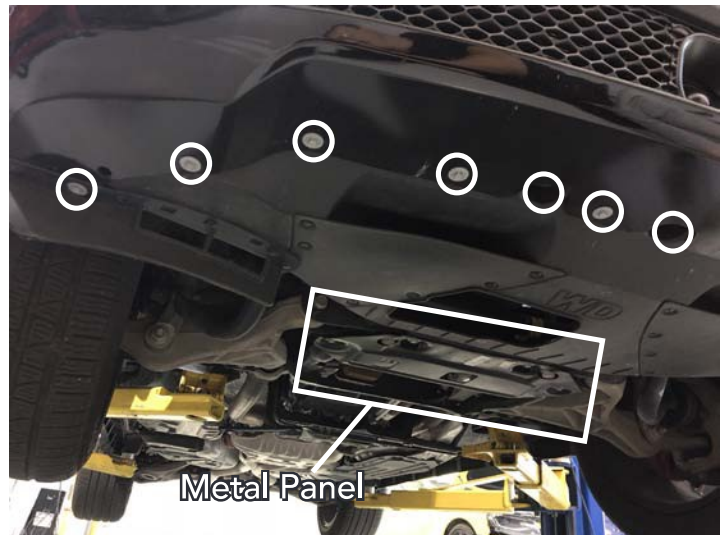

Splash Panel Bolts (7 of 13 shown)

- Remove (4) bolts on the rear metal plate securing the back of the splash panel. Remove the panel.

- Using a drill bit, drill out the center of the (2) rivets (one on each side) securing the corners of the splash panel to the fascia. Using a screwdriver remove the push pin located at the rear center of the splash panel. Remove the splash panel.



Push Pin and Rivet

Stock Component Removal

10 Behind the bumper on the passenger side, unplug the connector shown to the right.



Unplug Connector

11 Unclip fascia from fenders and below the headlights by pulling straight out. Unclip the panel at the top of the fascia and remove from vehicle.

12 From behind the drivers fender cut the heads off of (5) plastic rivets. On the other side of the fender liner remove the air duct.



Cut Rivets

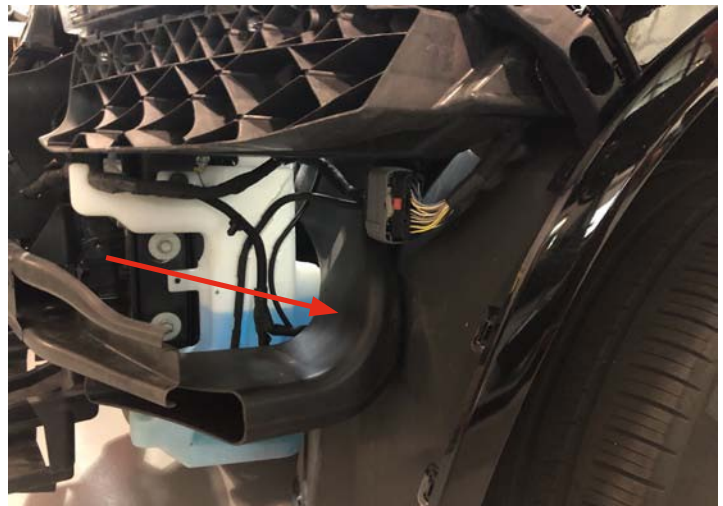

Remove Air Duct

Washer Reservoir

- 1 Remove the washer reservoir by removing the plastic clip with a flat head screwdriver near the fill cap.
- 2 On the reservoir unplug the electrical connectors for both pump(s) and low level sender.



Plastic Clip At Fill Cap

- 3 Place a drain pan underneath the washer reservoir and disconnect the hoses from the pumps (one pump for 2012-2013 Jeep models and Durango). Allow the reservoir to drain. Disconnect the push pin from the body holding one of the hoses. Unclip the hoses from the washer reservoir.

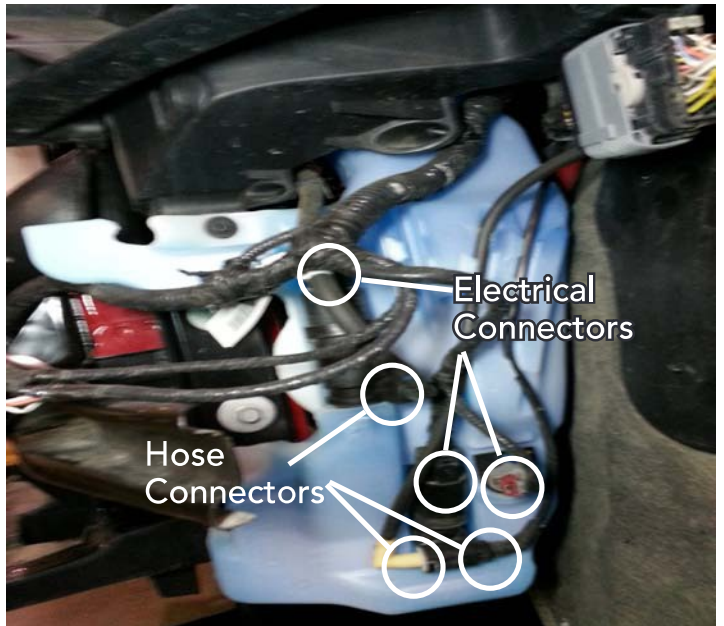

Washer Tank Hose & Electrical Connectors

- 4 2012-2013 Jeep:
Using an 8mm remove the (3) screws holding the reservoir to the body. Remove the reservoir.

2014+Jeep and Durango:
Using an 8mm remove the (2) screws holding the reservoir to the body. Remove the reservoir.

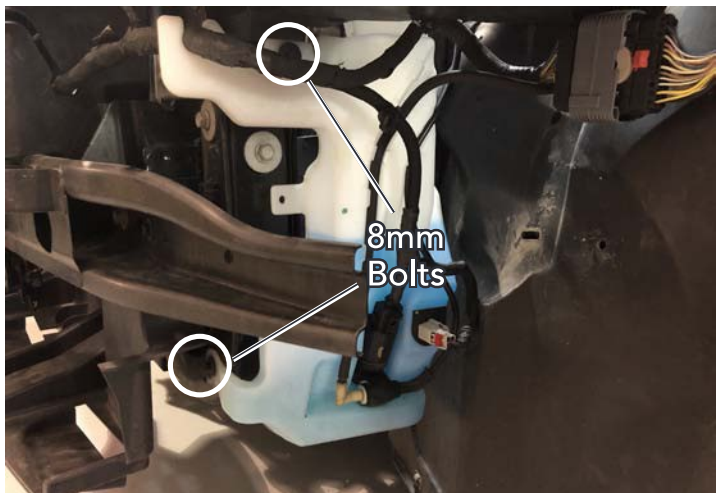

Washer Tank Bolts (Durango Shown)

Coolant Overflow

- 1 Disconnect the rubber hose going to the overflow tank from the radiator.
- 2 With an 8mm remove the (3) bolts holding the reservoir to the body.
- 3 Pull straight up and out on the overflow tank to remove it from the vehicle

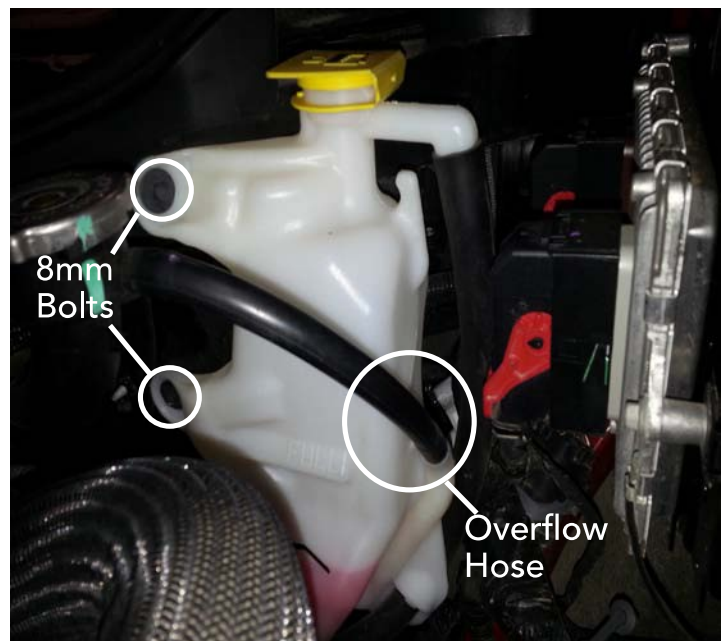

Coolant Overflow Tank

CRANK PULLEY

- 1 Place a drain pan under the radiator drain spout located on the drivers side of the radiator. Drain the radiator by loosening the knob on the drain spout.
- 2 To aid in radiator fan removal use a 10mm remove the bolt holding the A/C line to the radiator support. Push line to the drivers side.
- 3 Using a flat blade screwdriver pry up on the front of the radiator hose hold down clamp attached to the fan assembly. Push the clamp towards the engine to unclip it from the fan.
- 4 Using a pair of pliers squeeze the clamp at each end of the radiator hose and pull the hose off of the water pump and the radiator and remove from the vehicle.
- 5 Disconnect the fan wiring connector from the passenger side of the fan. With a screwdriver disconnect the power steering line clips from the fan. Push the fan retaining clips in to release the fan and pull the fan straight up to remove it from the vehicle.
- 6 Use a 15mm to remove the (8) bolts securing the torque converter access bracket under the vehicle.
- 7 Use a breaker bar between the torque converter bolts and the engine block to keep engine from rotating.



A/C Line Bolt



Radiator Hose Hold Down Clamp

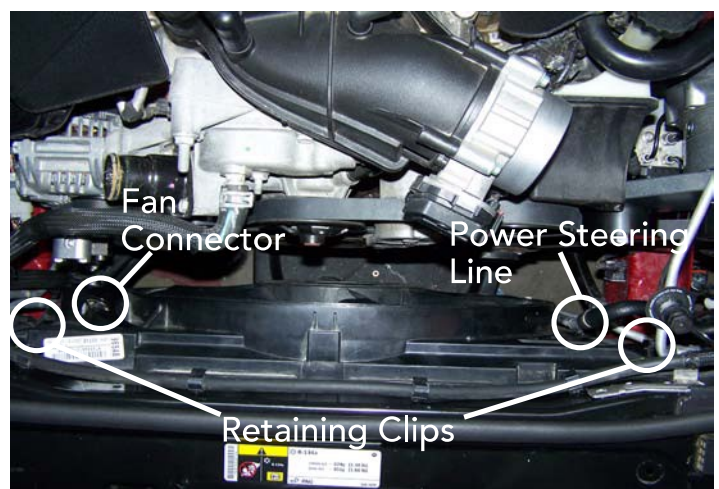

Fan Connections

Crank Pulley

- 8 Use a 21mm with a breaker bar to remove the crank bolt.
- 9 Place the drill jig onto the crank pulley, and tighten it into place using the supplied M14-1.50 x 120mm hex head bolt and washer.
- 10 Tape the supplied 1/4" HSS drill bit 1-5/8" from the tip. Using this taped bit, drill a hole in the crankshaft and harmonic balancer, stopping at the tape edge. The hole will be centered on the OD of the crankshaft. Do not drill deeper than .800" into the face of the crankshaft.
- 11 Remove the pinning tool and set aside. Clean the chips from inside the drilled hole and the surrounding area thoroughly.
- 12 Install the supplied 1/4" OD x .75" long stainless steel dowel pin in the hole. Re-install the crank pulley bolt and tighten to 129 ft-lbs.
- 13 Reinstall the converter access bracket and hardware.



Drilling the Crank



Crank Pulley Pinned to Crankshaft

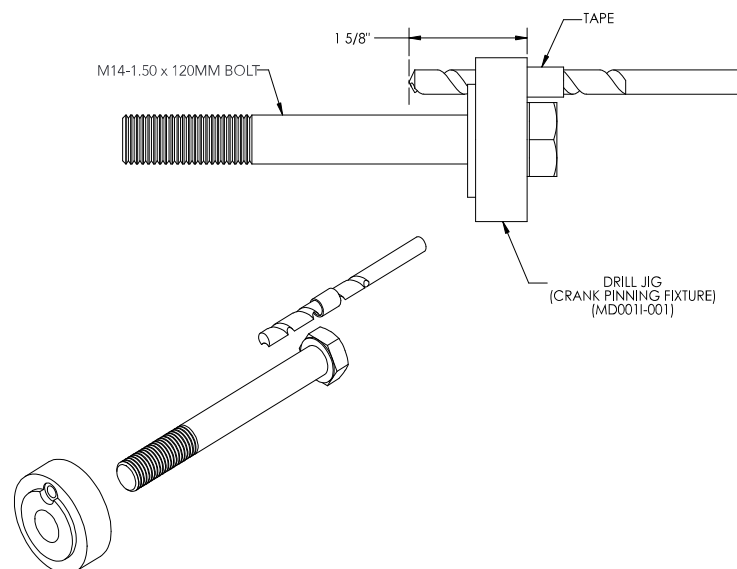

Crankshaft and Harmonic Balancer Drill Jig

SUPERCHARGER BRACKET ASSEMBLY

! **Warning:** Ensure there is clearance between the supercharger / bracket assembly and the ABS module / brake lines. Re-routing or modifications to the brake components may be required.

2012-15 Jeep Only 2016+ Jeep / Durango proceed to step 3.

1 To make room for the main bracket use a 16mm wrench to loosen the line at the bottom of the power steering pump and rotate it towards the engine. Retighten the line.

2 Disconnect the power steering return line and cap off the power steering nipple to keep fluid loss to a minimum. This line will be extended later.

3 Using a 3/8" breaker bar in the factory tensioner, rotate the tensioner counter-clockwise to remove the factory serpentine belt.

4 With a 16mm remove the factory belt tensioner.

2012-15 Jeep Model Years Only.

5 Using a 13mm remove the bottom power steering pump bolt (this is a main bracket mounting hole).

Proceed to step 7.

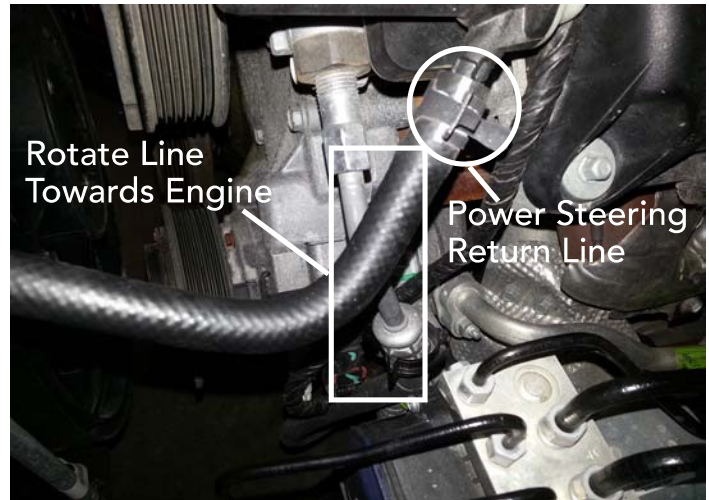

Power Steering Lines



Factory Tensioner

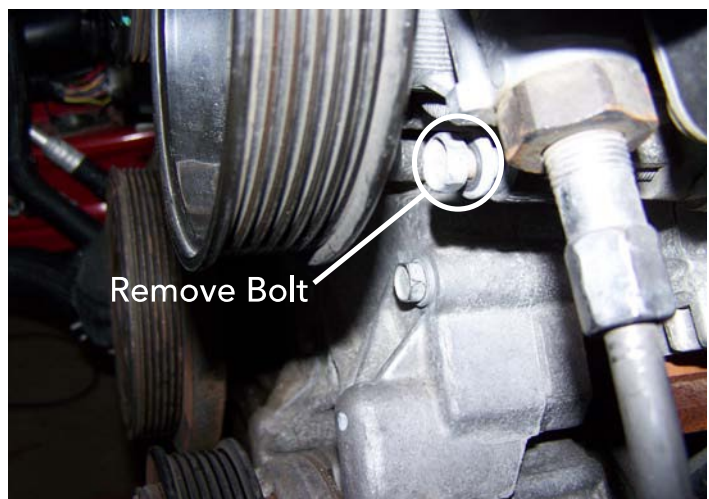

2012-15 P/S Pump

Supercharger Bracket Assembly

2016+ Jeep / Durango Only.

- 6 Using a 13mm remove the idler pulley bolt and the bottom bolt securing the idler bracket to the motor (the main bracket will mount to this hole). Remove the idler pulley.



2016+ Idler / Bracket

- 7 The main bracket bolts to (4) mounting points on the front of the engine. Use a 13mm to remove the (3) bolts shown to the right.

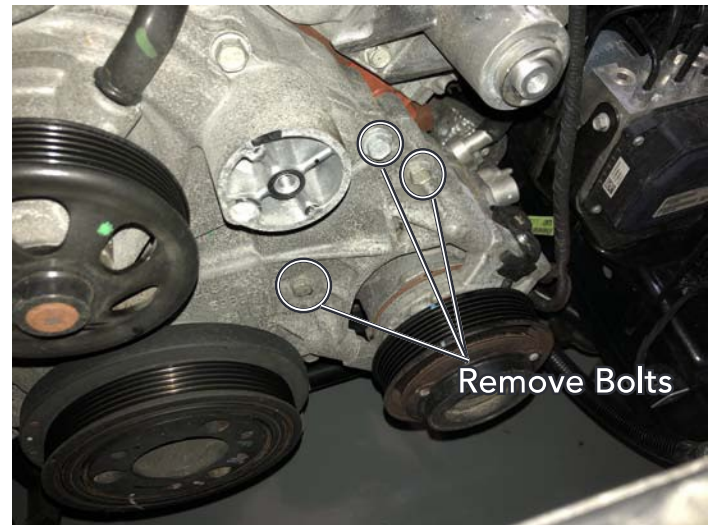

Bracket Mounting Points

- 8 Refer to the schematic below for bolt and spacer lengths for proper bracket installation.
- 9 Starting with the upper left bolt (M8X 60) and spacer loosely mount the bracket followed by the other bolts and spacer. The M8x100 bolt will have to be installed through the power steering pulley on 2012-15 model years (2016+ bolts straight onto the idler bracket). Tighten all hardware.
- 10 Reinstall the factory tensioner.



Main Bracket Installed



2016+Jeep / Durango 2.665" Spacer

2016+ Jeep / Durango Only.

- 11 Reinstall the Idler pulley.

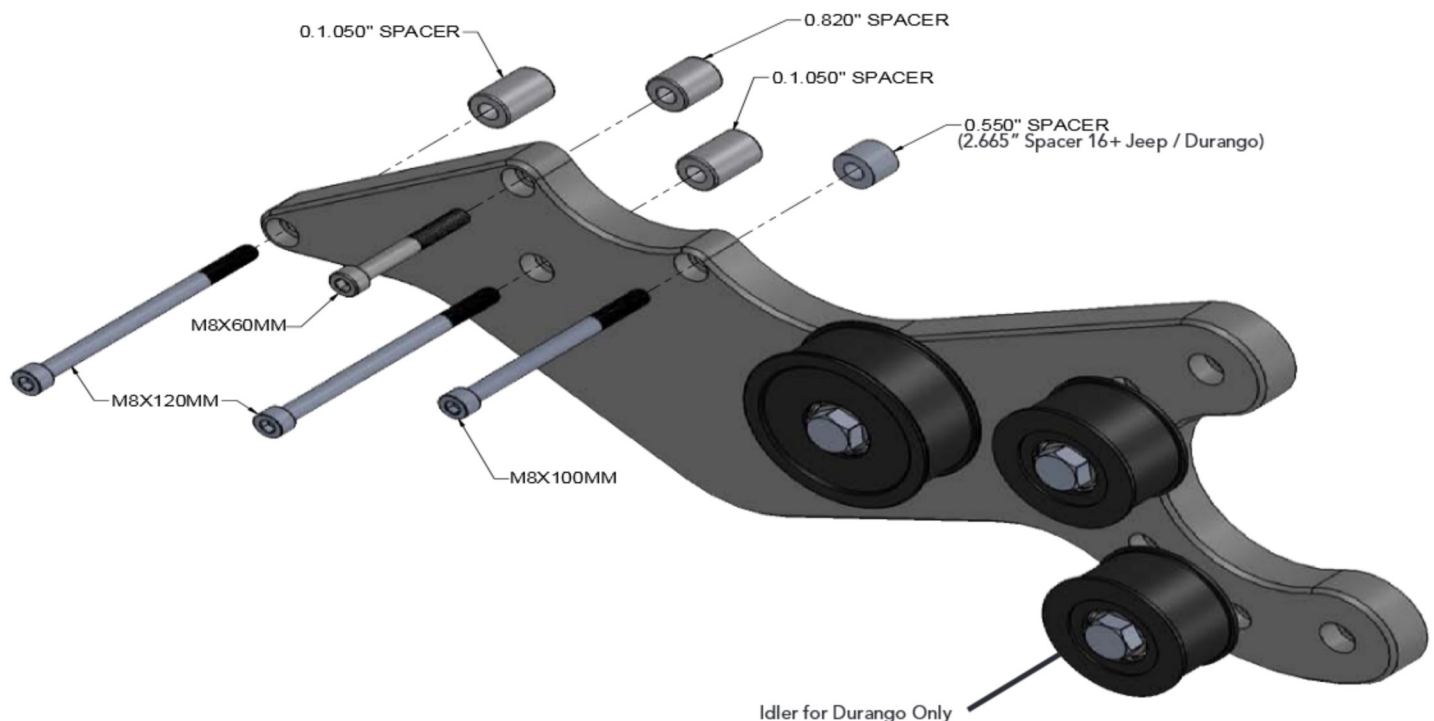

PROCHARGER HEAD UNIT

2012-15 Jeep Models only.

2016+ Jeep / Durango Proceed to step 3.

- 1 Using the provided 3/8"-3/8" barb connector and 3/8" hose, slide the barb connector into the power steering hose (that was removed in an earlier step) followed by the 3/8" line onto the barb. Slide the hose over the nipple on the power steering pump. Secure connections with the factory hose clamp and the provided #06 hose clamps.
- 2 Zip tie the power steering lines out of the way to gain clearance for the belt.
- 3 Remove the ProCharger oil fill reminder tag from the head unit. Install the supplied drain line and tighten the fittings.
- 4 Fill the head unit with one of the supplied bottles of ProCharger supercharger oil. You will need to remove the fill plug/dipstick using a flat headed screwdriver. After filling the head unit with oil, replace the fill plug/dipstick.
- 5 Remove the small idler from the bracket (if installed).
- 6 Fit the supercharger into the bracket.
- 7 With the 3/8-16 x 1" SHCS, start mounting the supercharger onto the bracket. Thread in the remaining four 5/16-18 x 7/8" SHCS. Tighten all SHCS.
- 8 Reinstall the small idler.

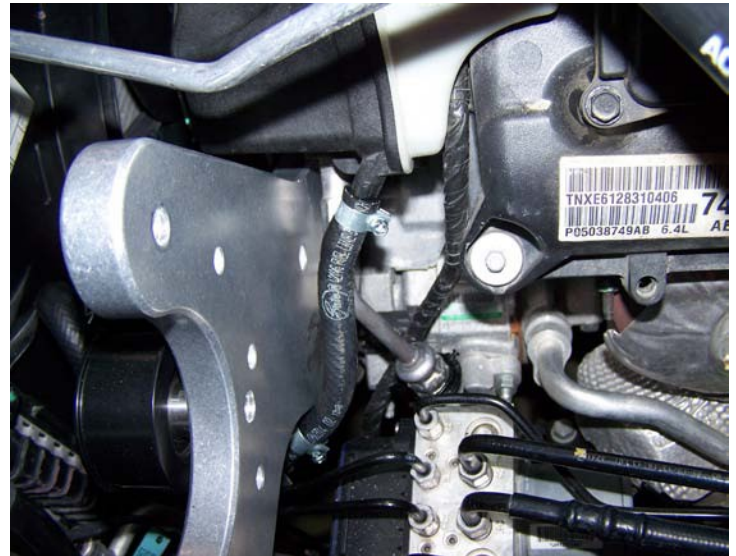

Power Steering line Extended



Procharger Head Unit Installed

TENSIONER

- 1 Using a 13mm remove the bolt shown to mount the tensioner bracket. The tensioner mounts to this hole and the existing tapped hole below it.
- 2 Mount the top tensioner bracket bolt and spacer loosely. Route the supplied belt around the tensioner and alternator. Install the bottom bolt and spacer, tighten the hardware. Refer to the picture to the right for proper bolt and spacer configuration.
- 3 Refer to the belt schematic below for proper belt routing.
- 4 Tension the belt using a 5/16 Allen socket on top of the tensioner turning it clockwise. Adjust the belt until the factory tensioner is at maximum travel. Tighten the tensioner idler pulley bolt with a 5/8 wrench.
- 5 Reinstall the factory fan and upper radiator hose at this time. Make sure to reattach all of the electrical connectors, lines and brackets.

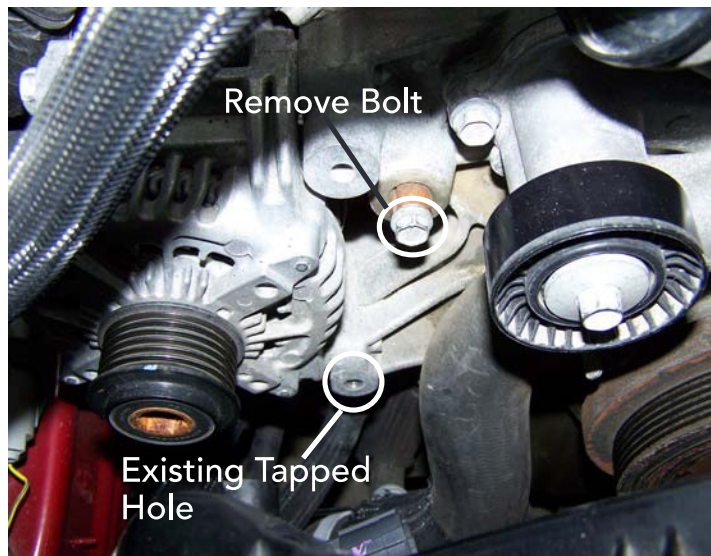

Tensioner Bracket Mounting Holes

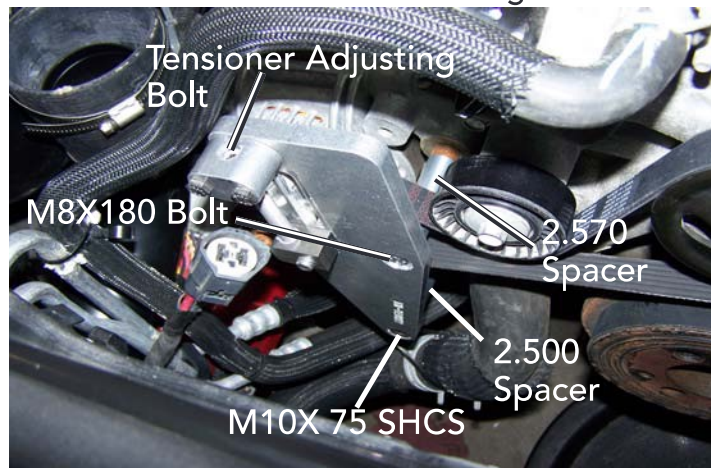

Tensioner Bracket Mounted

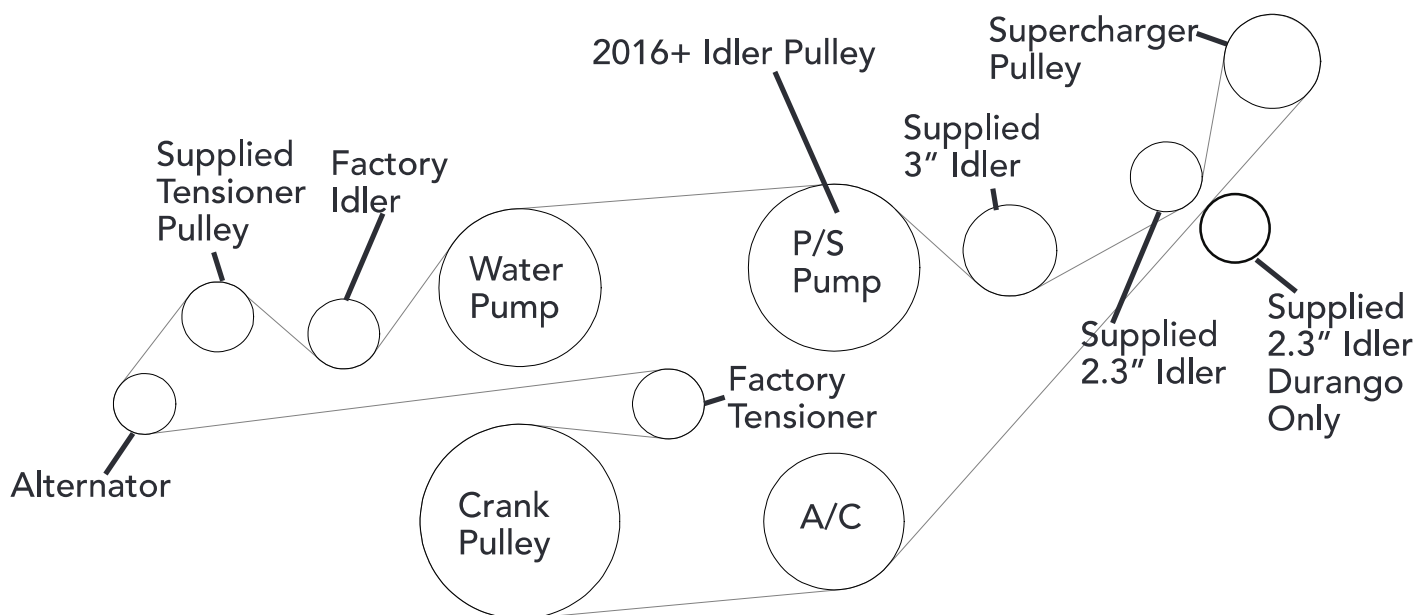

Belt Schematic

Intercooler

- 1 Remove the Ambient air temp sensor from the driver's side plastic air diverter held in place by (2) push pins (1 push pin on 2012-2013 Jeep / Durango models).



Ambient Air Temp Sensor / Air Diverter

- 2 Remove driver's side plastic air diverter by detaching the (2) plastic clips (1 clip on 2012-2013 Jeep / Durango models) holding it to the radiator core support. Reattach the clip(s) after removing the diverter.

- 3 Detach the harness clip from the passenger side air diverter. Remove passenger diverter. Reattach the clips after removing the diverter.



Driver's Side Horn Mounted

- 4 Using a 10mm remove the drivers side horn. Unclip the wiring harness from the radiator support. Use pliers to flatten the tab on the horn bracket. Use a 10mm to loosen the horn from the horn bracket.

✓ **Tech Tip:** Horn's may need to be switched from side to side for proper horn clocking.

- 5 Remove the 10mm bolt near the headlight. This will be used to mount the horn. Mount the horn and the bracket in the hole and position the horn as shown to the right. Tighten the horn to the bracket.

- 6 Using a 10mm remove the passenger side horn & bracket. Install the horn and bracket as shown using the supplied M6 bolt, washer and locknut.
- 7 Using a 13mm remove the (2) top bolts holding both radiator support brackets as shown to the right.



Passenger Side Horn Mounted

Durango Only

- 8 Remove the foam bumper cover by removing the (2) push pins securing it to the bumper.
- 9 Using a 10mm remove (2) bolts retaining the plastic brace. Remove plastic brace.
- 10 Re-install foam cover.



Radiator Support Brackets

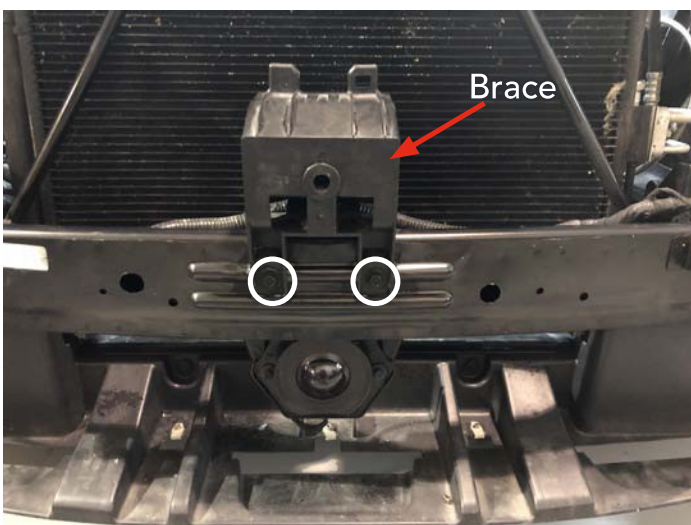

Remove Plastic Brace

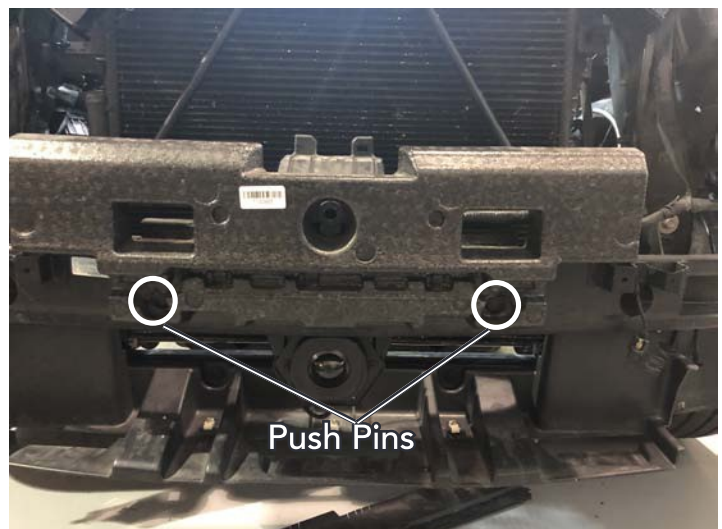

Foam Bumper Cover

Intercooler

Standard intercooler Jeep only, for race
Intercooler / Durango proceed to step: 12

- 11 Rotate the support brackets and bring them to the back side of the radiator support. The brackets will reattach to the back side of their original mounting location using the existing hardware. The hardware will also thread in from the back side. Secure the front of the bolts with the supplied M8 lock-nut and washer.



Radiator Support Brackets Relocated

Proceed to step: 15

Race intercooler / Durango only.

- 12 With a 10mm (8mm on some models) remove the bottom radiator support bracket bolt and remove the brackets from each side of the radiator support.

Durango proceed to Step: 18

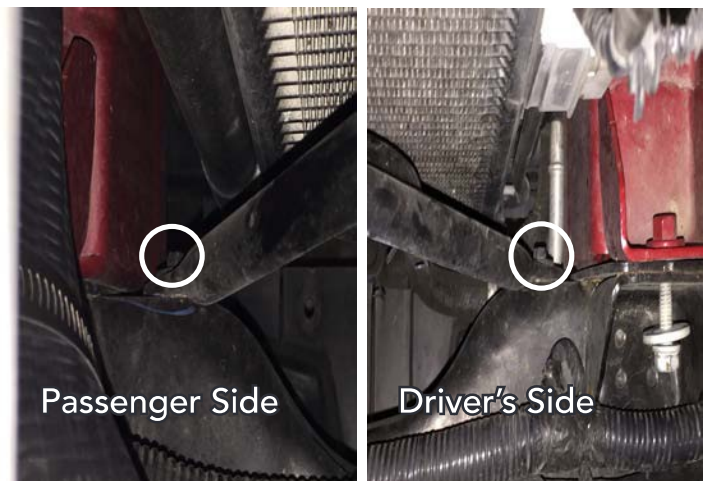

Remove Radiator Support Brackets

Race intercooler Only

- 13 Unplug the wire harness from the collision detection sensor. With a 10mm and 13mm remove the bumper bolts shown to the right, then remove the bumper from the vehicle.

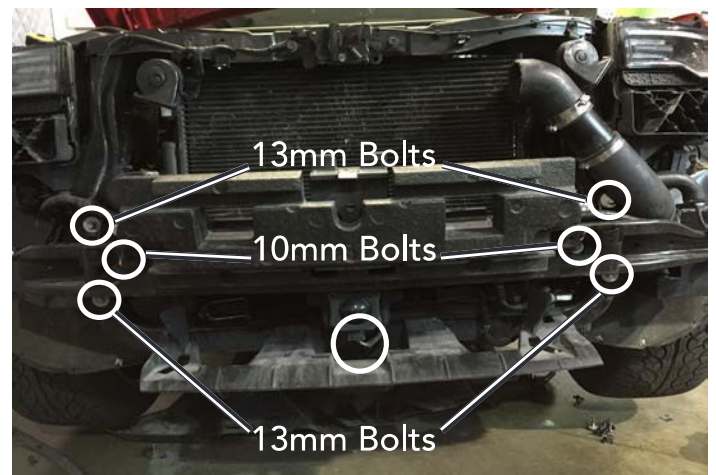

Remove Bumper Bolts / Unplug Sensor

2019+ Jeeps Skip to step 16

- 14** Using a flat tool as to not damage the A/C condenser pry out on the transmission cooler brackets. The brackets are held in place by a plastic clip on the back side of the A/C condenser.



Transmission cooler Back Clip

- 15** Move the transmission cooler to the bottom of the radiator as shown. Push the tabs on the cooler brackets into the A/C condenser, then reattach the clips on the back side of the brackets that were removed in the previous step.

- 16** Reinstall the bumper assembly making sure to plug in the collision detection sensor.

- 17** To make room for the intercooler unclip the wiring harness from the top of the bumper shown to the right, and move the harness down and behind the bumper. Zip-tie the harness to the bumper.



Unclip Transmission Cooler



Transmission Cooler Relocated



Move Wiring Harness

Intercooler

- 18 Mount the supplied intercooler brackets to the factory horn mounting locations, use the factory horn mounting hardware to loosely mount the brackets.

✓ **Tech Tip:** Some models will need to have the bracket mounded to the back side of the radiator support lip for more intercooler clearance.

- 19 With the supplied 3/8" bolts and washers, attach the intercooler as shown to the right. Push the intercooler back against the radiator support brackets to ensure plenty of grill clearance. Secure with a 9/16.

- 20 With a 13mm remove the bumper support bolt and attach the bottom intercooler bracket. Attach the bracket to the intercooler with the supplied 3/8" bolt and washer. Tighten all hardware.

- 21 Secure the ambient air temp sensor to the lower intercooler bracket with the factory push pin or a zip tie.



Passenger Side Intercooler Mounted



Driver's Side Intercooler Mounted



Intercooler Mounted

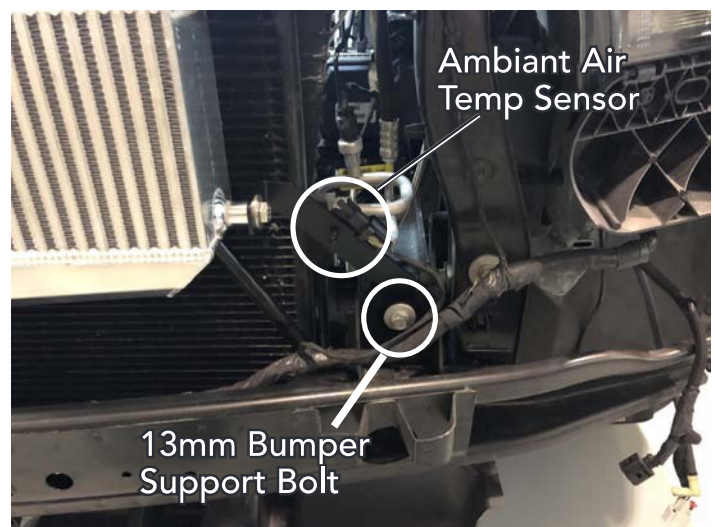

Bottom Intercooler Bracket Mounted

INTERCOOLER AND TUBING SCHEMATIC

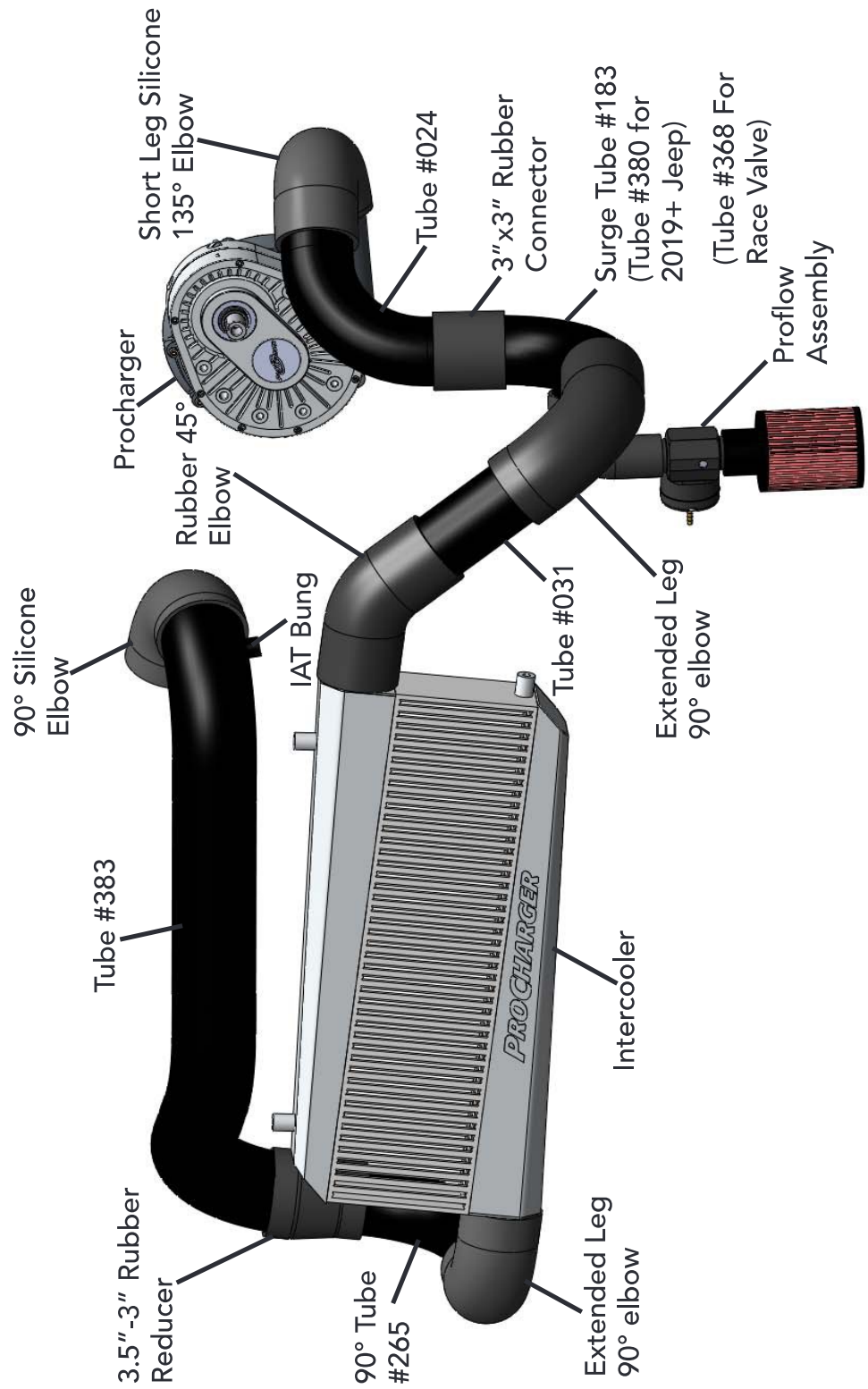

Intercooler

✓ **Tech Tip:** For easy adjustments, leave the clamps loose until the entire tube and hose assembly has been installed. Some trimming of rubber couplers may be needed. #52 hose clamps are used for all connections except on the silicone hoses.

✓ **Tech Tip:** Airbox stud may have to be cut off to clear the tube coming out of the supercharger.

18 Slide the silicone 135° elbow onto the outlet of the supercharger, the short leg goes onto the supercharger. Secure with a 3.38" T-bolt clamp.

✓ **Tech Tip:** On models equipped with headlight squirter be sure the tubing doesn't contact the squirter connection, the connector can be rotated to clear the tubing (as shown at the bottom of the page).

19 Insert tube #024 into the silicone elbow. Secure with a 3.25" T-bolt clamp.

20 Slide the 3" x 3" Rubber connector onto tube #024.

21 Insert surge tube #183 (Tube #380 for 2019+ Jeeps) into the 3" x 3" connector with the surge bung facing the frame rail.



Airbox Stud



Silicone 135° Elbow



Headlight Squirter Connection



3" x 3" Connector / Surge Tube

- 22 Unclip the horn harness from the radiator support to give slack in the main harness for tubing clearance.
- 23 Slide the 90° extended leg elbow onto surge tube #183 (Tube #380 for 2019+ Jeeps). Short leg connects to tube #183 (Tube #380 for 2019+ Jeeps). Make sure the main harness is routed under the tubing as shown. Tubing and wiring harness must be positioned as pictured to the right to clear the front fascia. Secure the horn harness to the radiator support.
- 24 Insert tube #031 into the extended leg 90° elbow.
- 25 Finish the connection by attaching the 45° rubber connector into tube #031. The short leg of the connector attaches to the intercooler.
- 26 Tighten all hose clamps at this time.
- 27 Slide the extended leg 90° rubber elbow onto the outlet of the intercooler. The shorter end connects to the intercooler.
- 28 Insert tube #265 into the rubber 90° elbow. The long leg goes into the rubber 90. Point the end of the 90° tube straight up.
- 29 Slide the 3.5"-3" rubber reducer onto tube #265.

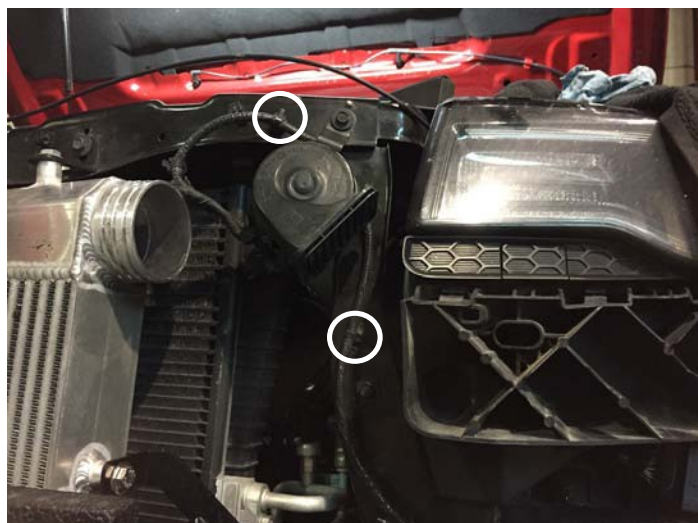

Horn Harness Clips



Wiring Harness Under Tubing

Tubing To Intercooler Installed



Tubing Out Of The Intercooler Installed

Intercooler

- 30 If equipped, before installing the throttle-body tube remove the (2) clips shown to the right to gain clearance for the tube
- 31 Plug the IAT sensor into tube #383. Lube the O-ring with dielectric grease. Push the sensor into the IAT bung and twist clockwise to lock it into place.
- 32 Plug the supplied IAT extension harness into the IAT sensor and into the factory harness. Zip tie the harness out of the way of the belt.
- 33 Insert tube #383 into the 3.5"-3" rubber reducer. Secure with a #64 hose clamp.
- 34 Slide the silicone 90° elbow onto tube #383 and onto the throttle body. Secure both connections with 3.75" T-bolt clamps.
- 35 Tighten all hose clamps at this time.



Remove Clips If Equipped



IAT Sensor Installed



Throttle Body Tube #383 Installed

WASHER TANK

- 1 Remove the pump(s) (2012-2013 models have one pump) from the factory windshield washer tank by first pulling outwards on the pump(s) to release them from the locking tabs, then pull up to remove them from the grommets. Remove the grommets.
- 2 Remove the level sender by carefully prying it out from the grommet. Remove the grommet.
- 3 2012-2013 Jeep / Durango:
Install the level sender and pump into the supplied washer tank as shown. The open hole gets plugged by the supplied plug (use silicone sealant on the plug to aid the seal). Lithium grease may need to be added to the pump grommet to aid in pump and grommet installation. Install the provided pump hold down using the supplied 5/16 bolt and washer.

2014+ Jeep:

Install the level sender and pump's into the supplied washer tank as shown. Lithium grease may need to be added to the grommet's to aid in pump and grommet installation. Install the provided pump hold down using the supplied 5/16 bolt and washer.

- 4 Install the washer tank. The tank connects to the factory bolt and stud on the drivers side of the radiator support as shown to the right.
- 5 With a 13mm remove the bolt on the radiator support.



Washer Tank With Pumps And Hold Down Installed 2014+ Jeep



Washer Tank With Pump And Plug 2012-13 Jeep / Durango

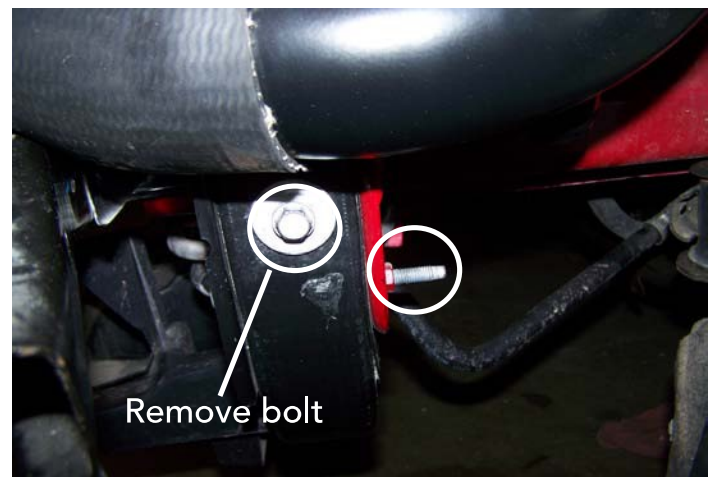

Washer Tank Mounting Points

Washer Tank

- 6 Insert the supplied M8 X 100 bolt and 5/16" washer through the washer tank bracket and install the bolt into the radiator support while sliding the other bracket over the stud sticking out of the radiator support. Tighten the bolt with a 13mm and secure the other bracket with the supplied M8 nut and washer.
- 7 Plug in all of the factory connectors and hoses to the washer tank pump(s) and level sender.
- 8 Slide the supplied molded hose up between the supercharger and the radiator support. Secure the hose to the washer tank with a #24 hose clamp.
- 9 Insert the supplied washer neck into the washer neck bracket and onto the molded hose.

✓ **Tech Tip:** Washer tank may need to be pushed towards the inner fender to clear the fascia on some models.

- 10 With a 10mm remove the bolt shown on the radiator support. Mount the washer neck bracket to the radiator support with the bolt removed earlier. Secure the hose to the neck with a #24 hose clamp.
- 11 Remove the cap from the factory washer tank. Cut off the mounting tab from the cap and install it onto the supplied washer neck.



Washer Tank Installed



Molded Hose Attached To Washer Tank

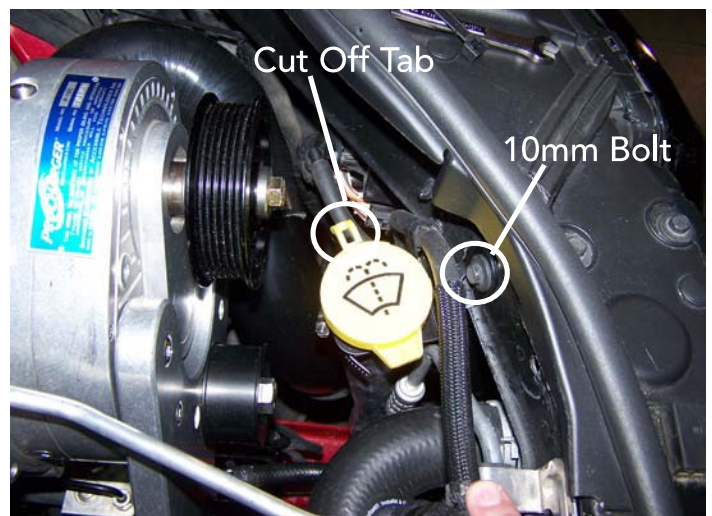

Washer Neck Installed

COOLANT RESERVOIR

- 1 Install the supplied clip nut onto the radiator support as shown. Some models do not have a hole for the clip nut, use a 1/4" drill bit to drill a hole using the dimensions to the right for location.
- 2 Loosely mount the coolant tank bracket to the radiator support utilizing the existing 10mm bolt.
- 3 Slide one section of the supplied 3/8" hose onto the barb fitting on the bottom fitting of the supplied coolant reservoir. Secure with a 3/8" hose clamp.
- 6 Slide the second section of 3/8" hose onto the fitting on the side of the supplied coolant reservoir. Secure with a 3/8" hose clamp.
- 4 Mount the reservoir to the clip nut using the supplied 1/4-20 bolt and washer. Attach the reservoir to the bracket using the supplied 8mm bolt and washer. Tighten all hardware.
- 5 Cut the bottom 3/8 hose to length to mount it to the nipple off of the radiator neck. Slide the hose over the nipple and secure with a 3/8" hose clamp. The remaining 3/8" hose needs to be routed towards the ground away from any moving objects (this hose is for venting purposes).
- 6 Remove the cap from the factory overflow bottle by pulling straight up on it. Install the cap onto the new supplied coolant reservoir.

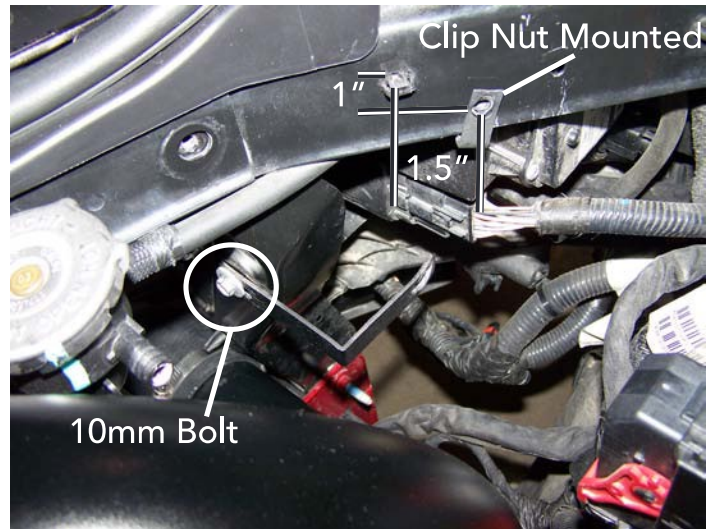

Coolant Tank Mounting Points



Coolant Hose Mounted

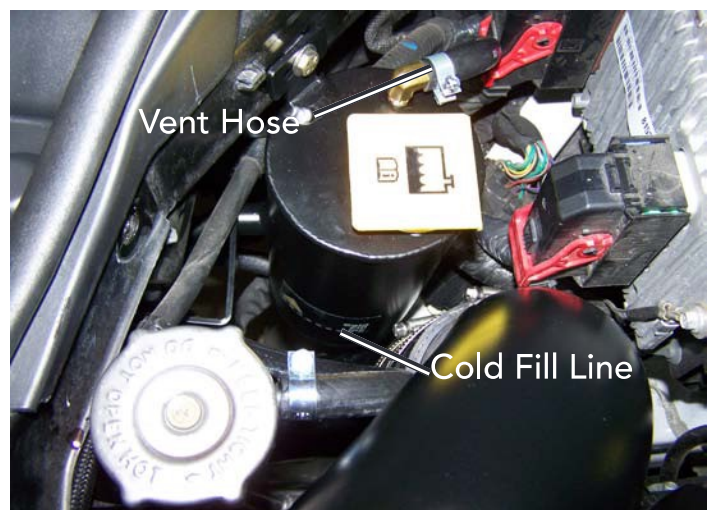

Coolant Tank Installed

VACUUM MANIFOLD

- 1** Assemble the supplied vacuum manifold as shown. If you have or are installing a boost gauge, do not install the plug, use an additional barb fitting. Thread each fitting into the manifold. Thread the 3/8" barbed fittings onto each end of the manifold.
- 2** Locate the brake booster hose on the driver's side near the firewall. Remove a 3-1/2" section of this hose in order to place the manifold in-line.
- 3** Mount the manifold by sliding each barbed fitting into the open ends of the brake booster hose. Secure the connections with the provided #06 hose clamps.
- 4** Be sure the brake booster hose connections are tight; verify the connection to the booster did not come loose as well.

! **Warning:** *Improper clamping of the splice into the brake booster hose could cause a vacuum leak and could cause the power brakes to become inoperable. Use extreme caution in installing the vacuum manifold to prevent any possible leaks.*

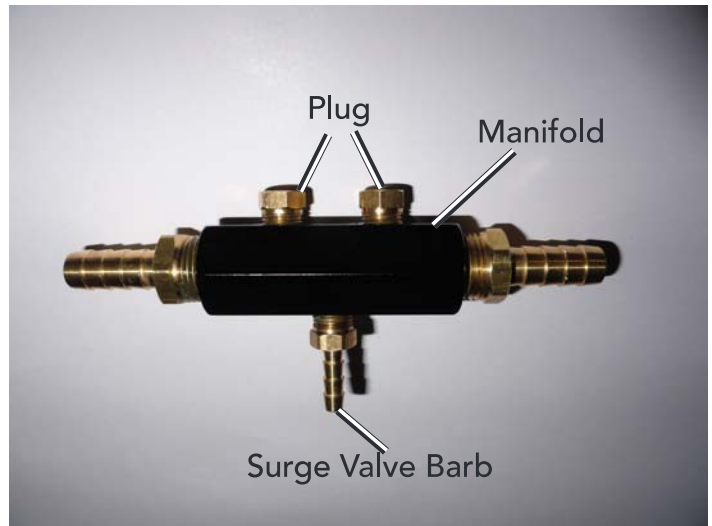

Vacuum Manifold Assembly



Vacuum Manifold Installed

SURGE SYSTEM

- 1 Slide the provided 90° rubber elbow onto the open 1-1/2" bung located on the surge tube #183 (Tube #380 for 2019+ Jeeps).
- 2 Slide the surge valve onto the open end of the rubber elbow in the orientation shown below. Ensure the surge valve linkage is free from obstruction. Place the filter onto the end of the valve.
- 3 Secure the connections with #24 hose clamps.
- 4 Using the provided 3/16" vacuum line, connect one end onto the barb located on the surge valve, and route it under the blower. Connect it to the open barb located on the vacuum manifold. Be sure to zip tie the line for clearance from moving components, as well as the exhaust manifold.

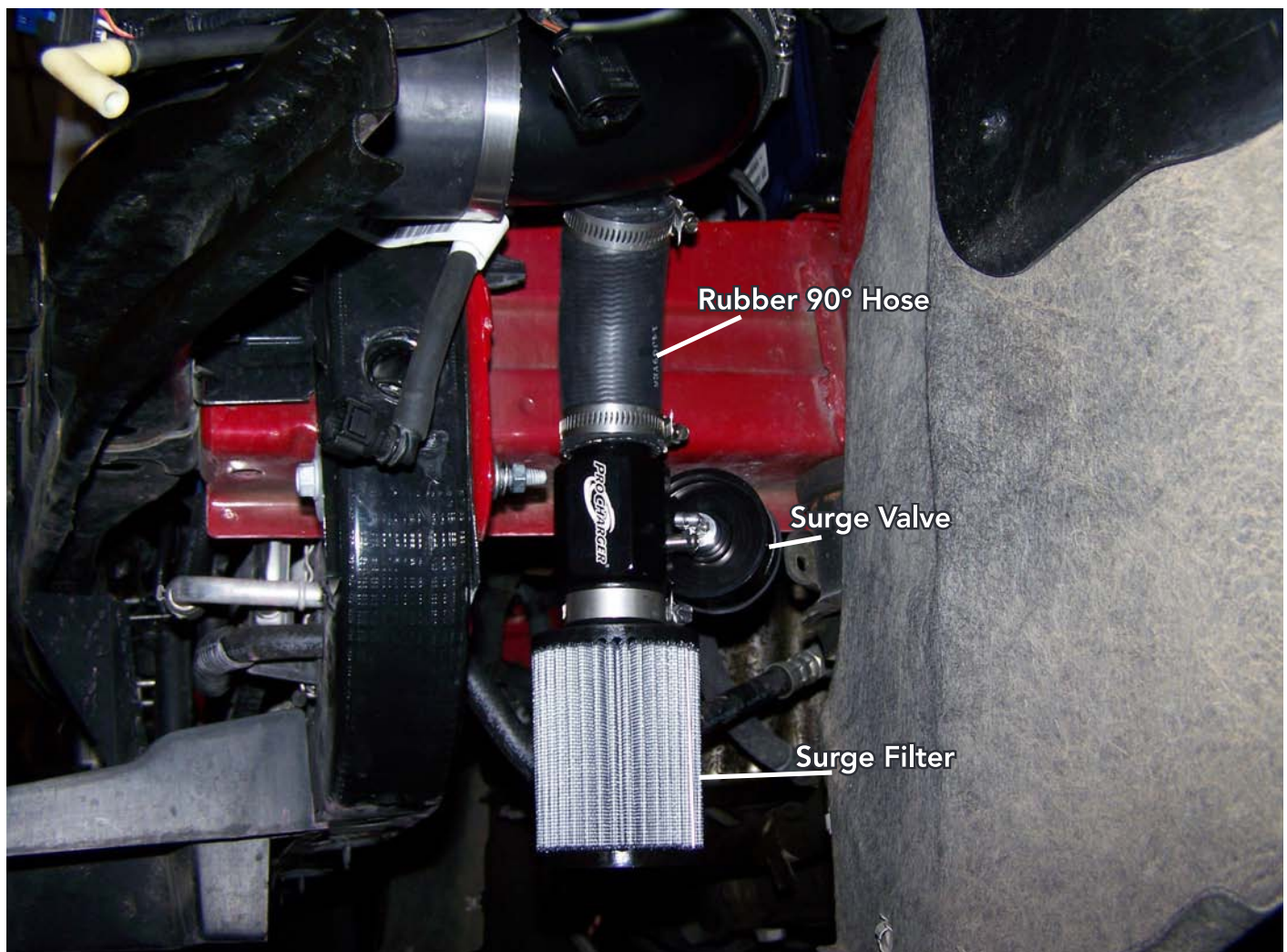

FUEL SYSTEM

- ✓ **Note:** This section only applies to full systems, which include upgraded fuel system components and tuning. If you do not have a full system, an upgraded fuel system and tuning will be required before starting the vehicle.

Fuel Injectors

- 1 Reconnect the battery.
 - 2 Remove the fuel pump relay from the panel in the passenger side of the engine compartment.
- ✓ **Tech Tip:** Check your owners manual to ensure you are pulling the proper relay.
- 3 Crank the engine for 15 seconds.
 - 4 Disconnect the battery.
 - 5 Unclip the wiring harnesses from each injector. Remove the four 10mm bolts securing the fuel rails to the manifold. Pull the fuel rails up off of the manifold to gain access to the fuel injectors.
 - 6 Remove the fuel injector retaining clips from the injectors and rails. Remove the injectors by pulling them straight out of the rails.
 - 7 Install the new injectors, followed by the factory retaining clips.
 - 8 Push the injector and rail assembly into place, and tighten the rails. Re-install each wiring harness to each injector. Reinstall the fuel pump relay.



Fuel Rails Installed

Map Sensor

- 1 Use a 7mm to remove the factory MAP sensor located on the passenger's side of the intake manifold. Remove the electrical harness by sliding the red retaining tab back and disconnecting it from the sensor.
- 2 Remove the O-ring from the factory MAP sensor and install it onto the supplied MAP adapter fitting. Insert the MAP adapter into the intake manifold and tighten using the factory screw.
- 3 Install the new supplied MAP sensor into the MAP adapter fitting with the (2) supplied M4 screws and tighten with a 7mm. Connect the electrical harness to the new MAP sensor.



MAP Adapter Installed



New MAP Sensor Installed

FINISHING

- 1 Locate the ambient air temperature sensor on the driver's side of the vehicle. Zip tie the sensor to the driver's side intercooler bracket .
- 2 Screw the supplied 3/8" MPT-1/2" 90° barb fitting into the supplied rotomold inlet. Slide the 1.5" section of 1/2" hose onto the barb fitting followed by the plastic 5/8" to 1/2" reducer as shown to the right.
- 3 Loosely place the supplied air filter onto the end of the rotomold inlet tube. Slide the inlet tube assembly onto the inlet of the supercharger, position the tube and secure with the supplied #64 hose clamp. Tighten the air filter hose clamp at this time.
- 4 Slide the factory PCV hose onto the plastic barb fitting on the inlet tube and secure with a #12 hose clamp.
- 5 Check for any fuel leaks.



Fitting, Rubber Hose and Plastic Reducer Installed Onto Inlet



Air Inlet Installed

Durango Only Jeep proceed to step: 7

- 6 The tabs shown to the right will need to be trimmed as well as the middle plastic protrusion.



Durango Fascia Trimmed

- 7 Reinstall the fascia using the supplied push pins on the wheel liner (2 sizes are provided for varying hole sizes).

✓ **Tech Tip:** Double sided molding tape is provided for the fender moldings.

- 8 Refill the coolant. Add coolant to the coolant tank to the cold fill line. Check coolant after first couple of drive cycles.

- 9 Re-install ECM.

- 10 Re-attach the battery connection.

- 11 Replace any power steering fluid that was lost.

- 12 Let the vehicle go through one heat cycle. This will allow the fluids to settle.

- 13 After turning the vehicle off, check fluid levels and add the appropriate amount of fluids.



Wheel Liner Push Pins (Jeep)



CONGRATULATIONS! YOU HAVE SUCCESSFULLY COMPLETED THE INSTALLATION OF YOUR NEW PROCHARGER SUPERCHARGER SYSTEM! PLEASE CONTINUE READING THE FOLLOWING PAGES FOR IMPORTANT INFORMATION ABOUT HOW TO MAINTAIN YOUR SUPERCHARGER SYSTEM.

OPERATION AND MAINTENANCE

Cold Starting

Never race your engine and ProCharger supercharger when your engine is cold. Allow the water temperature to climb into operating range for several minutes before driving above 2,500 rpm, to ensure adequate oil lubrication.

Fuel Quality

With a properly installed intercooled ProCharger supercharger system, detonation should not occur. For the best performance and reliability, use premium grade fuel (91 octane or higher). Listen for signs of detonation after refueling, and after replacement or modification of any fuel system component(s). If detonation occurs, reduce the throttle and locate the source.

Ignition System Maintenance

If your spark plugs are more than a year old or have more than 10,000 miles logged, you should consider changing them before driving your vehicle under load. Spark plug wires should be changed if visibly damaged or when resistance exceeds factory specifications.

Air Filter Maintenance

Your air filters should be cleaned periodically, potentially as often as every 10,000 miles or 6 months, even though a service interval of 50,000 - 100,000 miles is quoted by the manufacturer under normal driving conditions. A clogged air filter will result in decreased boost levels and vehicle performance. Be sure to re-oil the cleaned filter before re-installing. Always operate your vehicle with an air filter, failure to do so may result in damage to your ProCharger supercharger and personal injury!

Belt Replacement

The serpentine belt, which turns your ProCharger supercharger, will stretch after initial run-in, and should be retightened after the first hundred miles. Tighten the belt sufficiently to avoid slippage, but do not overtighten. Overtightening the belt could cause damage to the ProCharger supercharger's precision bearings. When re-installing the belt, use the belt routing diagram in this manual. If you reuse a thrown belt and find that it needs frequent re-tightening, the belt is damaged and should be replaced. Gates Micro-V belts can be bought from ATI or from your local parts store.

ProCharger Oil Change Intervals

The first oil change should be performed at 500 miles and at 6,000 mile intervals thereafter. Clean drain plug after every oil change. Drain oil by removing the drain plug. Clean off drain plug before re-installing.

ProCharger Oil Level

The ProCharger supercharger's oil level must be checked periodically to ensure the proper lubrication. The dipstick can be loosened using a flat blade screwdriver or a coin. When installed, the oil level should remain between the minimum (MIN) and maximum (MAX) indicators at all times.

! **Warning:** *Filling the ProCharger higher than the maximum level on the dipstick can lead to bearing and seal damage. The supercharger is a sealed unit and should not normally require the addition of oil between service intervals. If excessive usage is noted, the unit should be sent to ATI for inspection and repair. The dipstick fitting should be firmly tightened after changing or checking the oil level.*

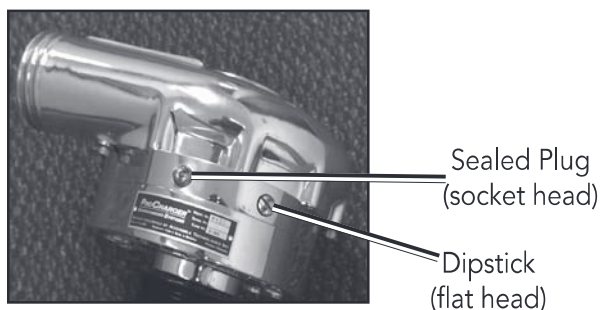
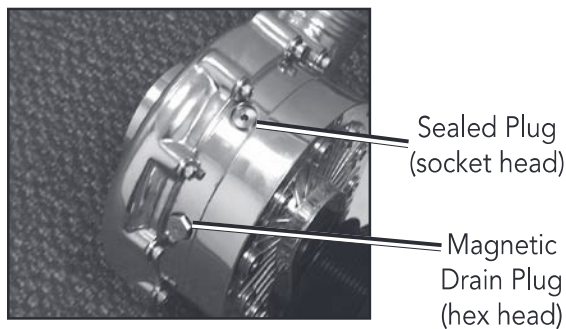

General

When removing the warning tag, be sure to retain the nylon washer. A spare nylon washer and o-ring is included. Use only the ATI supplied nylon washer and o-ring when servicing the oil dipstick and drain plug. A discoloration of the oil and residue on the drain plug may occur during the initial oil changes. This is normal and will gradually decrease. For the proper positioning of the ProCharger supercharger, the serial tag should be pointing upwards. Installing the ProCharger supercharger in another position will cause inadequate oiling and supercharger failure. If you have any questions about the maintenance of your supercharger, contact ATI.

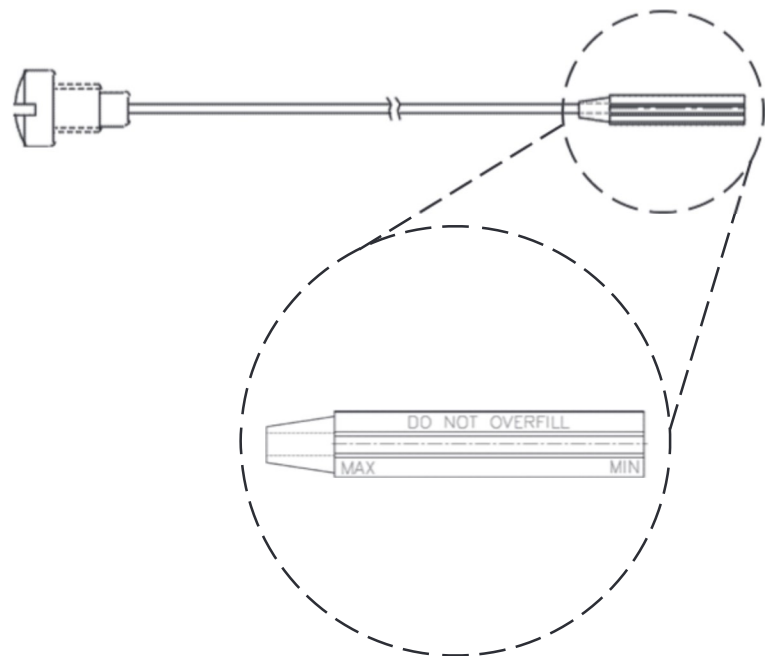

LIMITED WARRANTY

Accessible Technologies, Inc. (ATI) provides a limited twelve (12) month warranty on the ProCharger supercharger against defects in materials and workmanship unless otherwise specified. This limited warranty starts on the date of original purchase from your local dealer, or date of shipment from the factory. This limited warranty coverage is extended only to the original owner and excludes hoses, sleeves, and electronic components manufactured by other companies. IF THE SUPERCHARGER'S DRIVE RATIO IS ALTERED IN ANY WAY FROM THE FACTORY SETTING, WARRANTY COVERAGE IS VOID. USE OF ANY PULLEY NOT MANUFACTURED OR SUPPLIED BY ATI VOIDS ALL WARRANTY COVERAGE.

ATI's warranty obligations are limited to the terms below:

ATI agrees to honor a warranty claim at its sole discretion and only after inspection at the ATI factory. No warranty will be honored if any part of the product is found to have been improperly installed, tampered with, mishandled, or misused in any way. Disassembly of the ProCharger supercharger or removal of the ProCharger supercharger's serial plate voids all warranties. Claims for freight damages should be directed to the freight company.

If ATI's limited warranty applies, your product will be repaired or replaced at ATI's discretion and shipped back. If the limited warranty does not apply, ATI will advise you of the specific reason, cost of the repair, and delivery time. After advising you of this information we will, at your option, either proceed with repairs or return your product to you in the state in which it was received. In either case the product will be shipped to you, insured at replacement value. Therefore, you will pay the return shipping and insurance charges if ATI's limited warranty does not apply to your product.

THE WARRANTY AND REMEDIES SET FORTH ABOVE ARE EXCLUSIVE AND IN LIEU OF ALL OTHERS, ORAL OR WRITTEN, EXPRESS OR IMPLIED. THE DURATION OF ANY AND ALL WARRANTIES ON THE PRODUCTS DISCUSSED ARE LIMITED TO THE PERIOD IDENTIFIED ABOVE. ATI IS NOT RESPONSIBLE IN ANY EVENT FOR DIRECT, SPECIAL, INCIDENTAL OR CONSEQUENTIAL DAMAGES. No ATI dealer, agent, or employee is authorized to make any modification, extension, or addition to this warranty.

To obtain service under this warranty you must do the following during the warranty period:

Phone ATI (913-338-2886) and provide us with the following information:

- ProCharger supercharger serial number.
- Vehicle year, make, model, engine modifications, and other modifications.
- Description of perceived issue.

If a solution to your issue can not be found after the above phone consultation, you will be assigned a return authorization number (RMA). You must then properly package and ship your product, at your expense, to the ATI factory. The product should be carefully packaged in a rugged box.

Include the following information inside the box with your product:

- Copy of your original invoice or receipt.
- Name, address, and daytime telephone number.
- Return authorization number (RMA).
- Vehicle year, make, model, engine modifications, and other modifications.
- Description of perceived issue.

Clearly mark the warranty claim number on the top and one side of the box in characters at least 2" tall. Properly package the product and ship it, prepaid and insured for the retail value of the component(s) being returned, to the following address:

**Accessible Technologies, 14801 West 114th Terrace,
Lenexa, Kansas 66215**

This Page Is Left Intentionally Blank.

This Page Is Left Intentionally Blank.



**Accessible Technologies, Inc.
14801 W. 114th Terrace
Lenexa, KS 66215
Phone: 913.338.2886
Fax: 913.338.2879
techserv@procharger.com**

**Accessible Technologies, Inc.
©2020 ATI, All Rights Reserved
Part Number PMDL1A-001 Rev. R**

